

Smart Cake Adjustable Ø115 LED GE

127710XX_127713XX

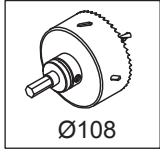

Ø108

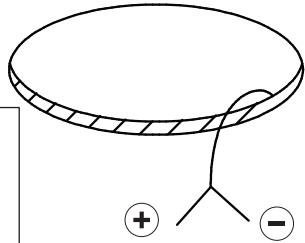

350mA - min 16,5Vf - max 19,2Vf - 6,2W
500mA - min 17,1Vf - max 19,8Vf - 9,2W

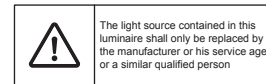
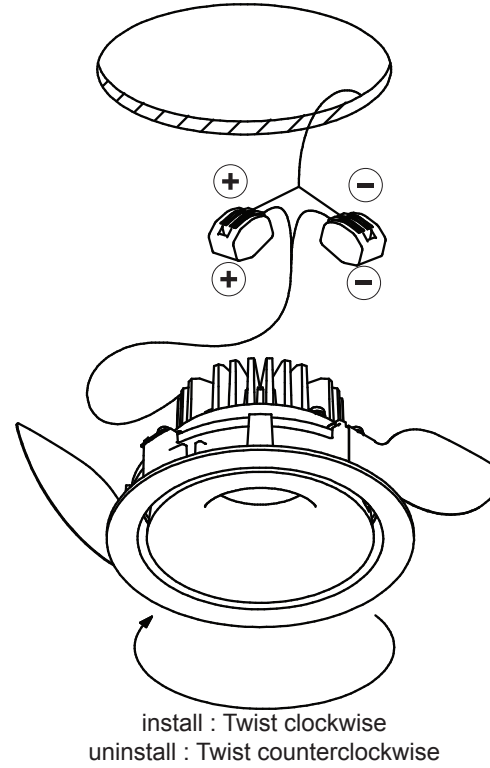
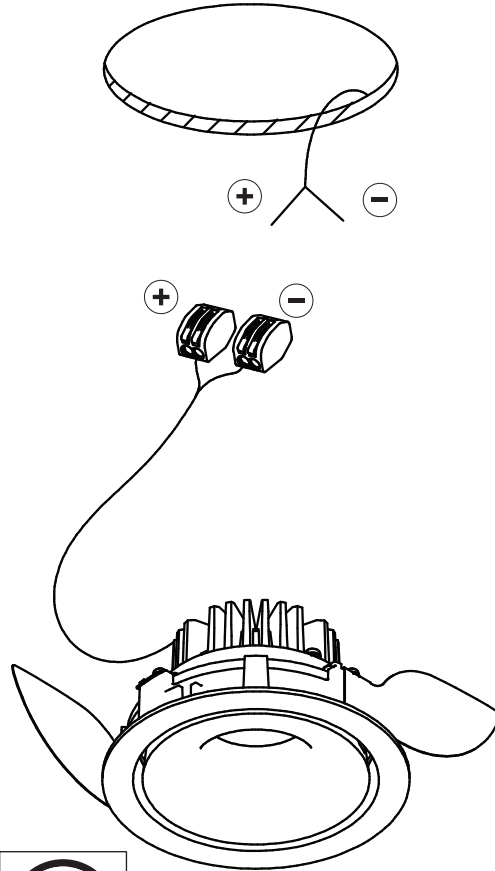
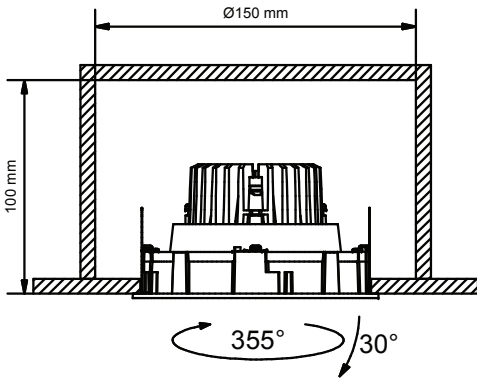

4

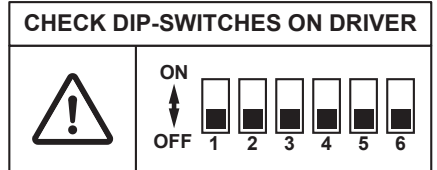
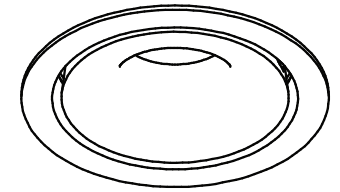

check dipswitch settings on driver
Push Dim max 5 drivers on 1 push button

Drivers:
see driver matrix - latest version on website
www.supermodular.com or check sales contact

