



WEVER & DUCRÉ
LIGHTING

DEEP bijou 1.0

165161W3C

Project

Type

Notities

Kwantiteit

Datum

ALGEMEEN

Plafond

Ingebouwd

Matwit

RAL 9003^a

IP20

Interieur

365 lm

LED

2700 K

CRI \geq 90

L80 / 50000 h

2-step binning

OPTISCH

Flood

Beam angle 30°

ELEKTRISCH

excl. driver

17 V

LED inset 4.5 W

250 mA

Klasse 3

Veiligheidsafstand 0.3 m

FYSISCH

Diameter 56 mm

Height 50 mm

0.1 kg

bladveren

CUTOUT

Diameter 50-52 mm

Min. ceiling thickness 4 mm

Recessed depth 85 mm

^a Color may deviate slightly due to production conditions.

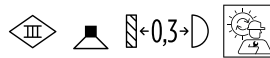

Ronde downlight van gegoten aluminium, voor plafondbouw; oppervlak Matwit; gepoedercoat; mat textuur; RAL 9003; gereedschapsloze installatie met behulp van bladveren; inbouwdiepte 85 mm; stralingshoek 30°; met COB (Chip on Board) technologie voor maximale efficiëntie; lichtkleur 2700 K; binning initial MacAdam \leq 2 SDCM; CRI \geq 90; UGR \leq 16; beschermingsgraad IP20; PC3; driver niet inbegrepen; lichtbron vervangbaar door gekwalificeerd personeel;



LICHTVERDELING

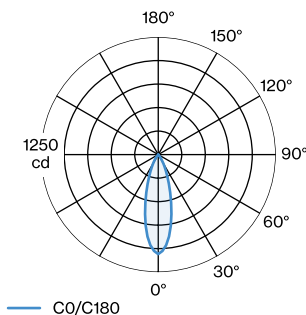



WEVER & DUCRÉ
LIGHTING

DEEP bijou 1.0

165161W3C

KEGELDIAGRAM

flood 30° 250mA

h (m)	EO° (lx)	ø (m)
1	1060	0.54
2	260	1.07
3	120	1.61
4	70	2.15
5	40	2.68

ELEKTRISCH

Driver

TYPE	L · W · H (MM)	ORDERCODE
7.2W 250mA 16-29V	122·41·23	9 0 2 2 6 4 0 1
10W 250mA 6-40V	124·31·21	9 0 2 4 9 4 0 2