

RoHS Compliant

[BOMcheck.net](https://www.bomcheck.net)

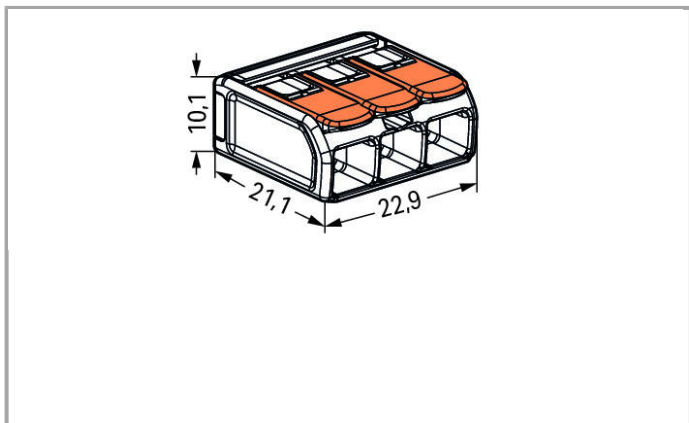

Gegevens
Electrical data



Ratings per IEC/EN 60664-1

Rated voltage (II / 2)	450 V
Rated impulse voltage (II / 2)	4 kV
Rated current	41 A
Legend (ratings)	(II / 2) \triangleq Overvoltage category II / Pollution degree 2

Connection data

Connection technology	CAGE CLAMP®
Actuation type	Lever
Connectable conductor materials	Copper
Nominal cross section	6 mm ²
Solid conductor	0.5 ... 6 mm ² / 20 ... 10 AWG
Stranded conductor	0.5 ... 6 mm ² / 20 ... 10 AWG
Fine-stranded conductor	0.5 ... 6 mm ² / 20 ... 10 AWG
Strip length	12 ... 14 mm / 0.47 ... 0.55 Inch
Total number of connection points	3
Total number of potentials	1
Type of wiring	Side-entry wiring

Geometrical Data

Width	22.9 mm / 0.902 inch
Height	10.1 mm / 0.398 inch
Depth	21.1 mm / 0.831 inch

Material Data

Color	transparent
Flammability class per UL94	V2
Weight	4.014 g

Environmental Requirements

Surrounding air (operating) temperature	85 °C
T-Marking per EN 60998	T85

Commercial data



Packaging type	BOX
Country of origin	DE
GTIN	4055143715416

Vergunningen / certificaten



Country specific Approvals

Logo	Vergunning	Certificaatsnaam
	KEMA/KEUR DEKRA Certification B.V.	71-101850

Ship Approvals



Logo	Vergunning	Certificaatsnaam
	DNV GL Det Norske Veritas, Germanischer Lloyd	TAE000015T
	LR Lloyds Register	04/20013 (E6)

UL-Approvals

Logo	Vergunning	Certificaatsnaam
	UL Underwriters Laboratories Inc.	E201573
	UL Underwriters Laboratories Inc.	E69654

Relevante producten

Mounting adapter

	Artikelnummer: 221-510 Mounting carrier; 221 Series - 6 mm ² ; for DIN-35 rail mounting/screw mounting	www.wago.com/221-510
	Artikelnummer: 222-505 Strain relief plate; for mounting carrier; 221 or 222 Series, can be snapped	www.wago.com/222-505

Downloads smartDATA

CAD data

3D Download 221-613	URL	Download



Wijzigingen voorbehouden

WAGO BeLux nv/sa
Excelsiorlaan 11
1930 Zaventem
Telefoon: +32 (0)2 717 90 90 | Fax: +32 (0)2 717 90 99
E-mail: info-be@wago.com | Web: www.wago.be

Hebt u vragen over onze producten?
U kunt ons telefonisch bereiken op het nr. {0}.