

PRODUCT DATA SHEET

Part number	479406
EAN	4015609020690
Manufacturer	WALTHER-WERKE
WEEE-Reg.-Number:	DE 22131895

Product description

Waterproof panel socket straight 125A 4P 6h with flange 114x114mm



Product image



Detailed product description

WALTHER Panel socket 125A 4P 400V 6h IP67
 straight
 made from PA6 material
 back-of-hand-proof in accordance with BGV A3
 soft transition
 radius from flange to collar
 flange 114x114
 fixing center 90x90, with multi-contact

Ordering Information

Order unit	Piece
Customs number	85366990
Net weight	1,155 kg
Packing quantity (VPE)	2
Length of the packaging	0,31 m
Width of the packaging	0,195 m
Depth of the packaging	0,14 m
Gross weight(VPE)	2,458 kg

Certificates

VDE certification	123029	
UL certification	No. E83342	
EAC certification	BY112.02.01.020 06089	

Classification system

Classification system	ETIM_6.0
ETIM Class	EC001317

Technical product data

IEC-amperage	125 A
Amperage acc. UL/CSA (for UL-version)	100 A
Number of poles	4
Voltage acc. EN 60309-2	400 V (50+60 Hz) red
Clock hour position	6 h
Identification colour	Red
RAL-number	3000
Degree of protection (IP)	IP67
Connection system	Screwed terminal
Angle of plug	Straight
Material	Plastic
Military model	False
Flange size vertical	114 mm
Drill hole distance vertical	90 mm
Flange size horizontal	114 mm
Drill hole distance horizontal	90 mm

Dimension sheet

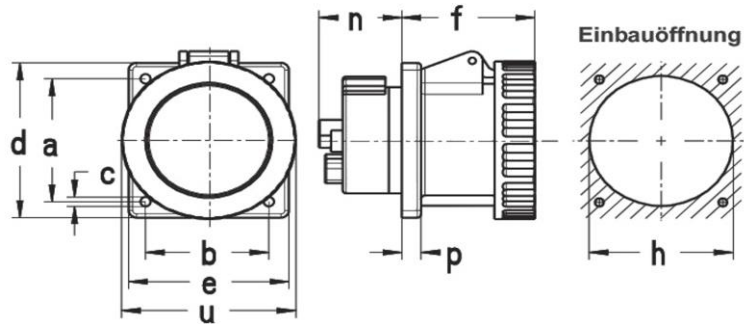

Amp.	125		
Pole	3	4	5
a	90	90	90
b	90	90	90
c	6,5	6,5	6,5
d	114	114	114
e	114	114	114
f	96	96	96
h	90	90	90
n	64	64	64
p	12	12	12
u	130	130	130