



Fiche Technique

IRC 230/400V-8A



Marque	EREA
Numéro d'article	IRC 230/400V-8A
Code-EAN Barcode	5414503004468
Code	2031
Type de produit	Limiteur de courant d'enclenchement

Dimensions

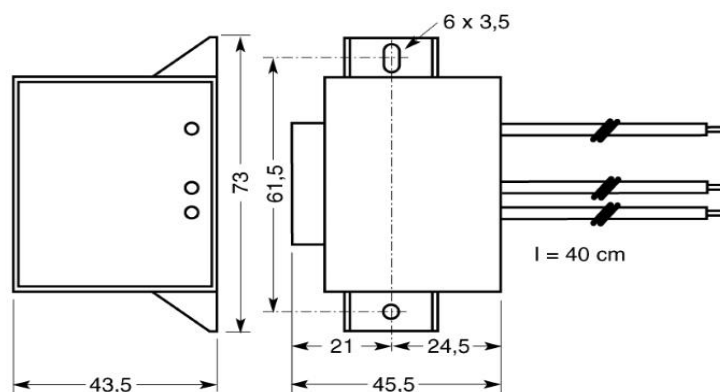

Schémas de raccordement

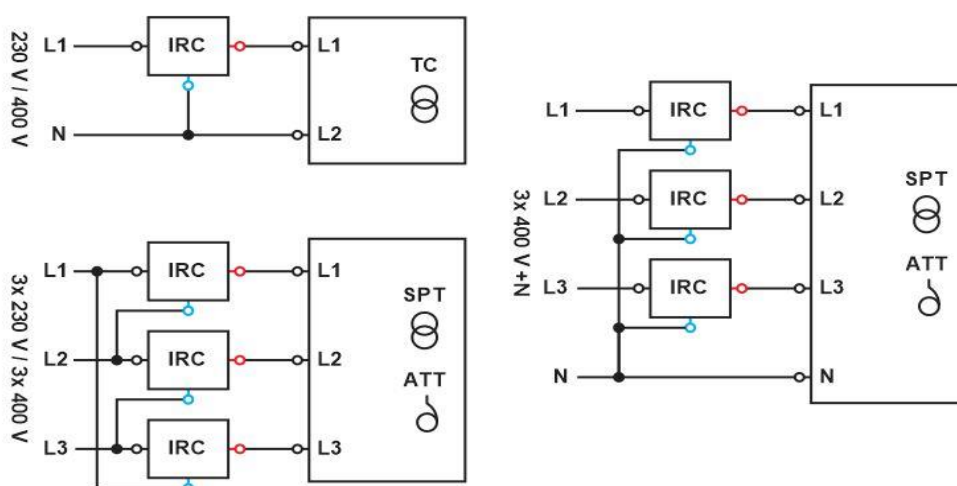

rev. 03.12.2020