

Smart Cake 82 IP LED Warm Dim GE

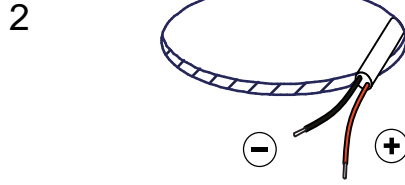

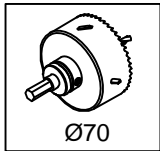

124140XX_124141XX_124142XX

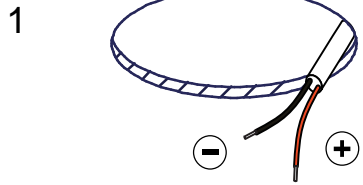

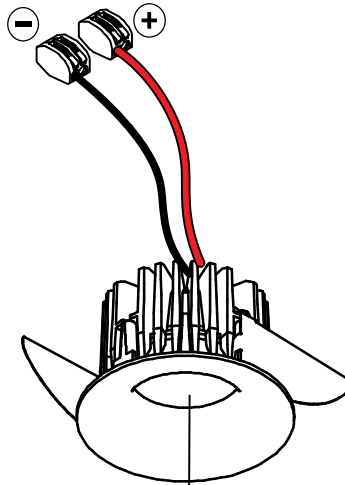
Drive Current (mA)	Forward Voltage		Power (W)
	min (Vf)	max (Vf)	
350	31	36	12

For serial connection, respect polarity!



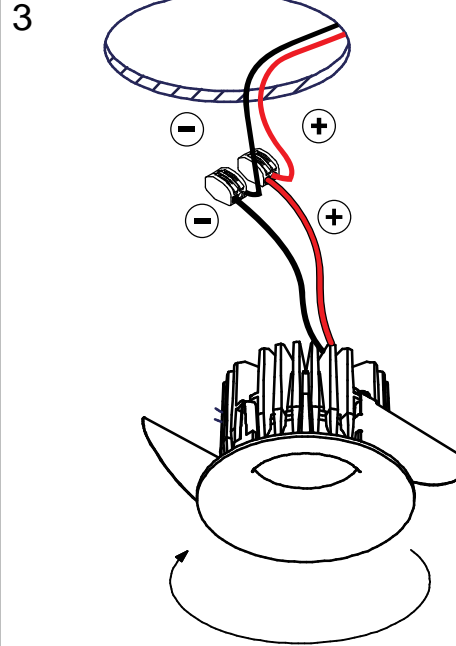

 Replace protective shield when broken. The luminaire shall only be used complete with its protective shield. Reference number: 1010754



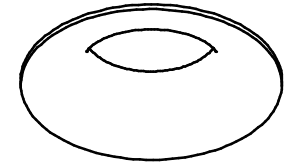

install : Twist clockwise
uninstall : Twist counterclockwise

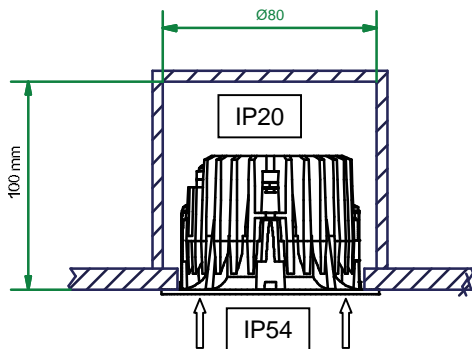

 The light source contained in this luminaire shall only be replaced by the manufacturer or his service agent or a similar qualified person



CAN BE USED WITH

Drivers:
see driver matrix - latest version on website
www.supermodular.com or check sales contact

Recessed ring:
12500230 Recessed ring Ø70 H100

Surface box:
125160XX Smart SBS 82 GE for LED
125161XX Smart SBD 82 GE for 2xLED

Gypkit - conbox
12290130 Gypkit 190X190X Ø70
10889830 Conbox outer dim. 190x192x130

Mask:
12500009 Smart Mask 82 1x WhStr
12500032 Smart Mask 82 1x BiStr
12500046 Smart Mask 82 1x Gold
12500109 Smart Mask 82 2Lx WhStr
12500132 Smart Mask 82 2Lx BiStr
12500146 Smart Mask 82 2Lx Gold

