

Mini multiple for 1x LED GE

131300XX

CEILING

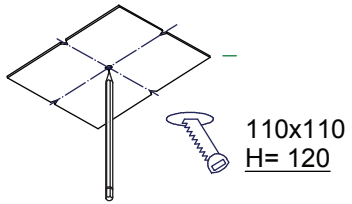

Conbox has to be combined with gypkit !!!
10400130+10420130

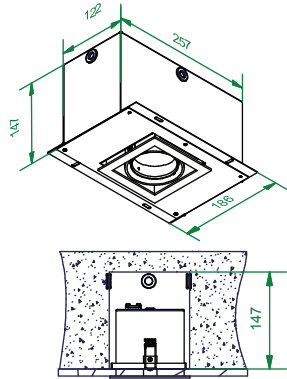

Gypkit :10420130 Mini-multiple 1x gypkit

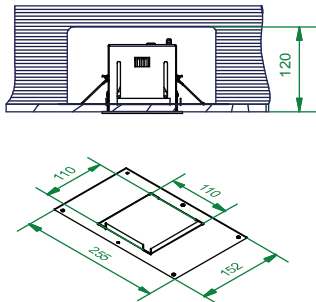

Don't connect the gear to 230V before the LEDs are connected to the gear!

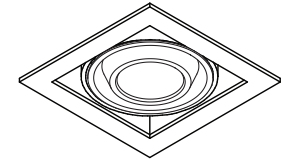
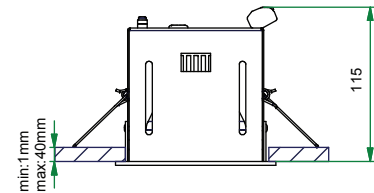
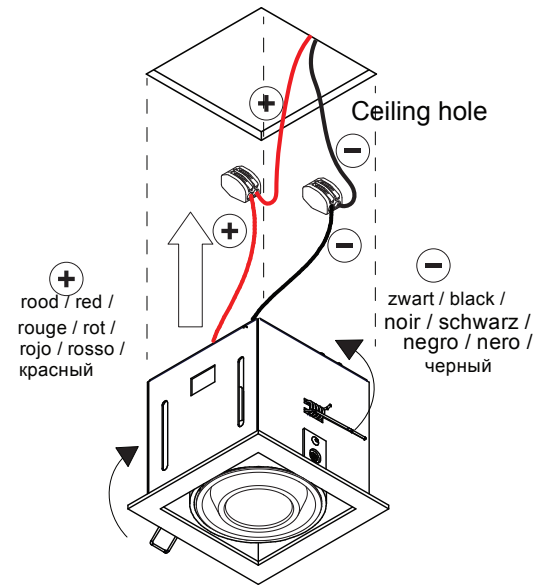
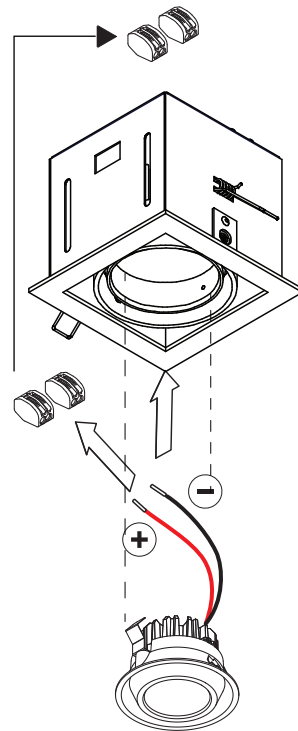
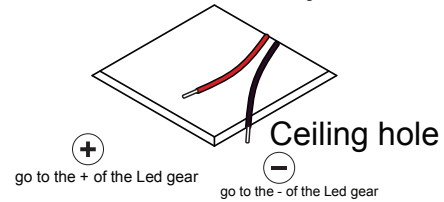

MUST BE USED WITH

14070002	M LED MOD 70 2,7KS GE BI
14070009	M LED MOD 70 2,7KS GE WhStr
14070102	M LED MOD 70 2,7KM GE BI
14070109	M LED MOD 70 2,7KM GE WhStr
14070202	M LED MOD 70 2,7KF GE BI
14070209	M LED MOD 70 2,7KF GE WhStr
14070302	M LED MOD 70 3KS GE BI
14070309	M LED MOD 70 3KS GE WhStr
14070402	M LED MOD 70 3KM GE BI
14070409	M LED MOD 70 3KM GE WhStr
14070502	M LED MOD 70 3KF GE BI
14070509	M LED MOD 70 3KF GE WhStr
14070602	M LED MOD 70 4KS GE BI
14070609	M LED MOD 70 4KS GE WhStr
14070702	M LED MOD 70 4KM GE BI
14070709	M LED MOD 70 4KM GE WhStr
14070802	M LED MOD 70 4KF GE BI
14070809	M LED MOD 70 4KF GE WhStr

CAN BE USED WITH

Drivers:
see driver matrix - latest version on website
www.supermodular.com or check sales contact

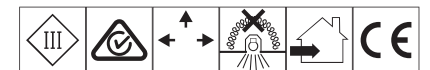

VO - 21/08/2015