

Frame Square/Wall Frame Square Maxi



☐ ⚡ **CE IP66 IK10**

220-240V, 50/60Hz (Sensor 50Hz)

NO: Skru av strømmen før montering
EN: Turn off power before installing
FR: Couper le courant avant l'installation
NL: Stroom uitschakelen voor u het toestel installeert
DE: Vor Installationsarbeiten den Strom abschalten.
FI: Sammuta virta ennen kytkemistä.

● 0,5 - 1,0 mm² 8 mm

● 1,5 - 2,5 mm² 12 mm

ca 10° (max. 20°)
Max 16 A



NO: Kan kun installeres av en registrert installasjonsvirksomhet
EN: Only to be installed by an authorized electrician
FR: Doit être installé par un électricien autorisé
NL: Mag alleen geïnstalleerd worden door een bevoegde elektricien
DE: Dieses Produkt darf nur durch autorisiertes Personal (z. B. Elektro-Installateur) angeschlossen und in Betrieb genommen werden.
FI: Asentaa saa vain valtuutettu sähköasentaja.

Frame Square/Wall

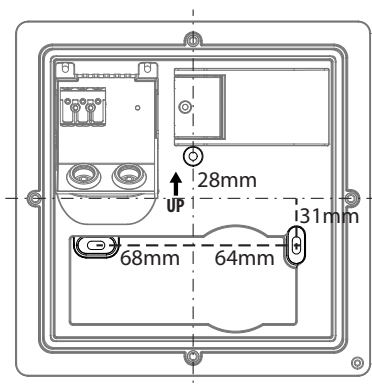

Frame Square Maxi

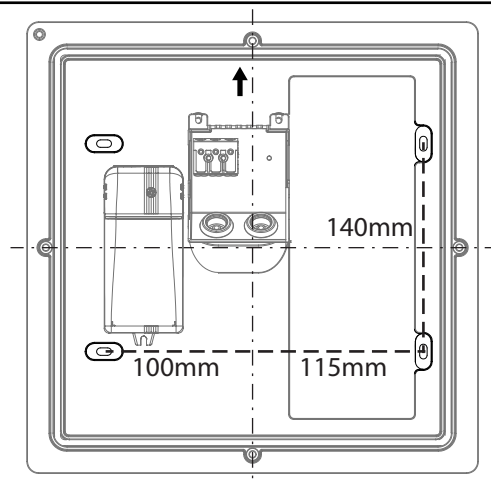

CORPORATE OFFICE:
SG Armaturen AS
Skytterheia 25
4790 Lillesand
NORGE

BRANCH OFFICE:
SG Lighting SA/NV
Blokhuistraat 47
2800 Mechelen Noord I
BELGIQUE/BELGIË

Tlf:+32(0) 15 20 72 71
info.benelux@silighting.net
www.silighting.net

BRANCH OFFICE:
SG Armaturen A/S
Egebakken 19
7400 Herning
DANMARK

Tlf:+45 70 70 72 13
info@sg-as.dk
www.sg-as.dk

BRANCH OFFICE:
SG Lighting SA/NV
73 rue de Saint Mandrier
83140 Six Fours Les Plages
FRANCE

Tlf:+33(0) 4 94 93 00 00
info.france@silighting.fr
www.silighting.net

BRANCH OFFICE:
SG Leuchten GmbH
Postfach 67 04 21
22344 Hamburg
GERMANY

Tlf:+49 40 23 99 44 59
info@sg-leuchten.de
www.sg-leuchten.de



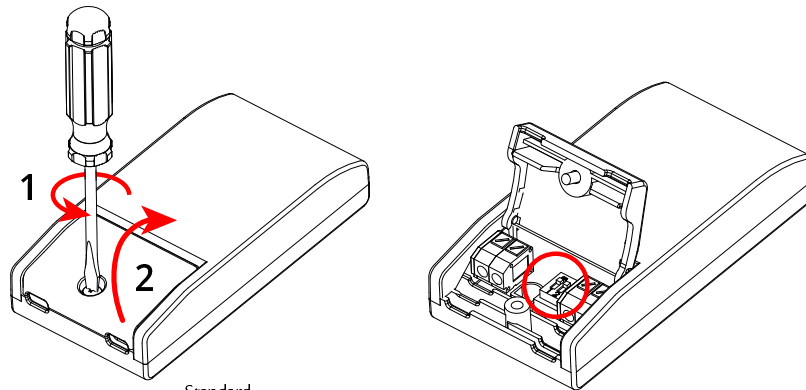

BRANCH OFFICE:
SG Armaturen AB
August Barksg. 30B
421 32 Västra Frölunda
SVERIGE

Tlf:+46 31 81 71 10
info@sg-ab.se
www.sg-ab.se

Frame
Square/Wall







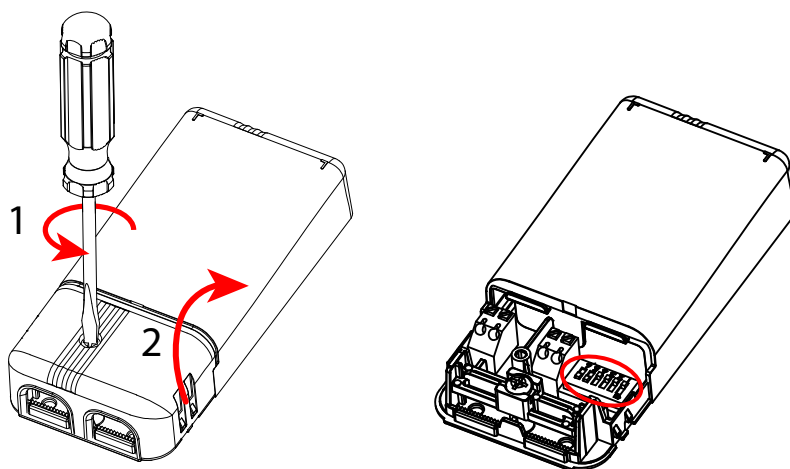

Standard

				
mA	180	205	230	255
W	5,8	6,6	7,5	8,3
lm	100%	114%	130%	140%

Frame
Square
Maxi



Standard

							
mA	250	300	350	400	450	500	550
W	10	12	14	16	18	20	22
lm	45%	55%	64%	73%	82%	90%	100%



mA	600-900mA	12/24/28V
----	-----------	----------------------

HC009S sensor



230V, 50Hz

40-60%

60-80%

0-10%

0%

80-90%

Standby power		< 0.5W
Microwave frequency		5.8GHz+/-75MHz
Microwave power		< 0.2mW

	1	2	3	
I	●	●	●	100%
II	○	●	●	75%
III	●	○	●	50%
IV	●	●	○	25%
V	○	○	○	10%

	1	2	3	4	
I	●	●	●	●	5s
II	○	●	●	●	30s
III	●	○	●	●	1min
IV	●	●	○	●	5min
V	●	●	●	○	15min
VI	○	○	○	○	30min

	1	2	3	4	
I	●	●	●	●	2 Lux
II	○	●	●	●	5 Lux
III	●	○	●	●	10 Lux
IV	●	●	○	●	30 Lux
V	●	●	●	○	50 Lux
VI	○	○	○	○	Disable

Max 400W

ceiling mounting pattern (m)

Sensor:

wall mounting pattern (m)

Sensor + Basic light:

<p>CORPORATE OFFICE: SG Armaturen AS Skytterheia 25 4790 Lillesand NORGE</p> <p>Tlf:+47 37 50 03 00 firmapost@sg-as.no www.sg-as.no</p>	<p>BRANCH OFFICE: SG Lighting SA/NV Blokhuisstraat 47 2800 Mechelen Noord I BELGIQUE/BELGIË</p> <p>Tlf:+32(0) 15 20 72 71 info.benelux@sglighting.net www.sglighting.net</p>	<p>BRANCH OFFICE: SG Armaturen A/S Egebakken 19 7400 Herning DANMARK</p> <p>Tlf:+45 70 70 72 13 info@sg-as.dk www.sg-as.dk</p>	<p>BRANCH OFFICE: SG Lighting SA/NV 73 rue de Saint Mandrier 83140 Six Fours Les Plages FRANCE</p> <p>Tlf:+33(0) 4 94 93 00 00 info.france@sglighting.fr www.sglighting.net</p>	<p>BRANCH OFFICE: SG Leuchten GmbH Nordstrasse 53 59399 Olfen GERMANY</p> <p>Tlf:+49 2595 3870 725 info@sg-leuchten.de www.sg-leuchten.de</p>	<p>BRANCH OFFICE: SG Armaturen AB August Barksg. 30B 421 32 Västra Frölunda SVERIGE</p> <p>Tlf:+46 31 81 71 10 info@sg-ab.se www.sg-ab.se</p>
---	---	---	--	--	--

Rev: 11.10.2017

Twilight sensor





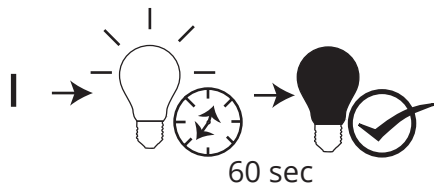



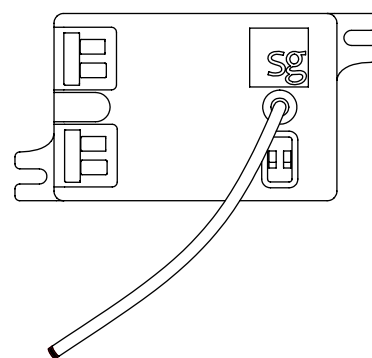
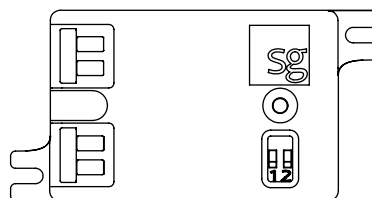

230V, 50/60Hz



	< 0,5 W
Max.	200 W

IR	
IR	LED



		SWITCH		SENSOR		
		S1	S2	Sensor LUX Level	Open (LUX)	Close (LUX)
Standard		ON	ON		100	150
		ON	OFF		80	130
		OFF	ON		70	120
		OFF	OFF		50	100

Rev: 12.01.2018

NORWAY SG Armaturen AS
Tlf:+47 37 50 03 00
firmapost@sg-as.no
www.sg-as.no

SWEDEN SG Armaturen AB
Tel: +46 31 81 71 10
info@sg-ab.se
www.sg-ab.se

FRANCE SG Lighting SA/NV
Tel: +33(0) 4 94 93 00 00
info.france@sglighting.fr
www.sglighting.net

GERMANY SG Leuchten GmbH
Tel: +49 40 23 99 44 59
info@sg-leuchten.de
www.sg-leuchten.de

DENMARK SG Armaturen A/S
Tel: +45 70 70 72 13
info@sg-as.dk
www.sg-as.dk

FINLAND SG Armaturen Oy
info@sg-oy.fi
www.sg-oy.fi

BENELUX SG Lighting SA/NV
Tel: +32(0) 15 20 72 71
info.benelux@sglighting.net
www.sglighting.net

INTERNATIONAL SG Lighting Co Ltd.
Tel: +86 769 88 49 20 88
cindy@sgdgc.com
www.sg-as.com