

Smart Cake 115 LED GE

127410XX - 127411XX - 127412XX - 127413XX - 127414XX - 127415XX -
127416XX - 127417XX - 127418XX

Lamp type : LED array

1

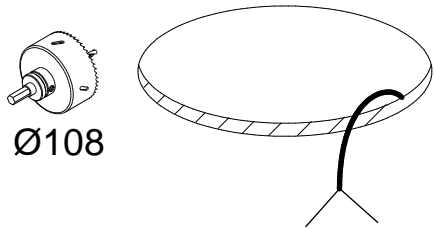

Ø108

350mA - min 29,1Vf - max 33,7Vf - 11W
500mA - min 29,9Vf - max 34,7Vf - 16,2W
700mA - min 31,0Vf - max 35,8Vf - 23,4W
900mA - min 31,7Vf - max 36,9Vf - 31,2W

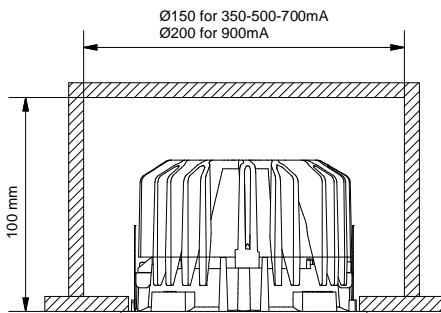

2

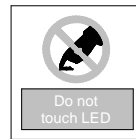
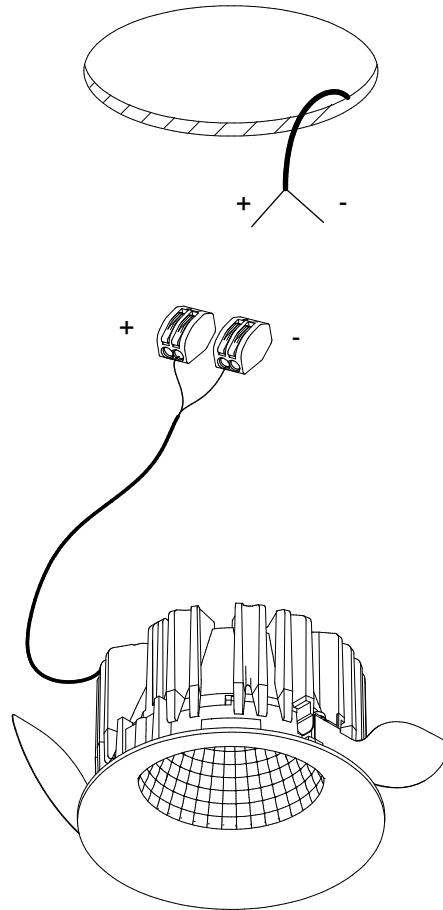

3

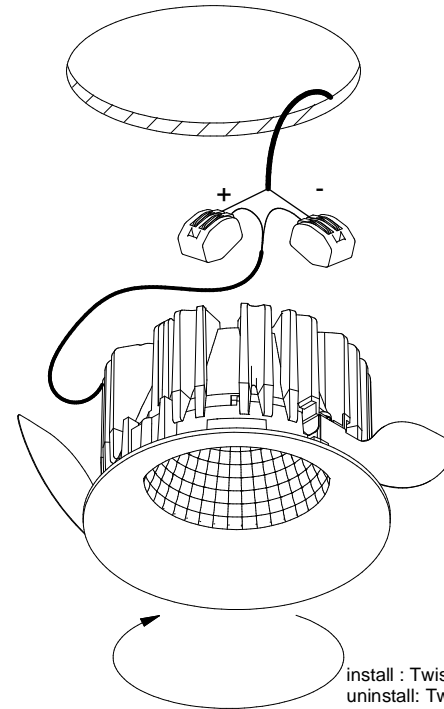

4

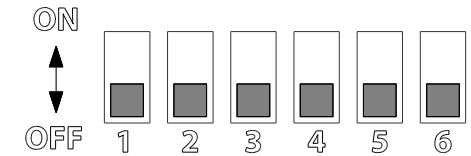
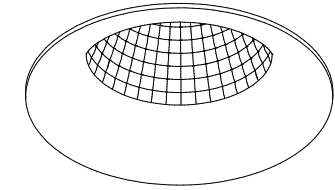

check dipswitch settings on driver
Max 900mA mounted in ceiling
Max 700mA mounted in Surface Box



Push Dim max 5 drivers on 1 push button

The light source contained in this luminaire shall only be replaced by the manufacturer or his service agent or a similar qualified person

install : Twist clockwise
uninstall: Twist counterclockwise

CAN BE USED WITH

drivers

see driver matrix - latest version on website
www.supermodular.com or check sales contact

Recessed ring

12810230 Smart recessed ring ø115

Surface box

128000xx Smart Surface box dia 115 GI for 1 LED GE
128001xx Smart surface box dia 115 1-10V/pushdim GI for 1 LED GE
128002xx Smart surface box dia 115 dali/pushdim GI for 1 LED GE
128010xx Smart surface box dia 115 GI for 2x LED GE
128011xx Smart surface box dia 115 1-10V/pushdim GI for 2x LED GE
128012xx Smart surface box dia 115 dali/pushdim GI for 2x LED GE

Gypkit - conbox

12290530 Gypkit 190X190XDIA108
10889830 Conbox outer dim. 190x192x130

Mask

12810009 Smart mask ø115 1x Whstr
12810032 Smart mask ø115 1x Blstr
12810046 Smart mask ø115 1x Gold
12810109 Smart mask ø115 2x Whstr
12810132 Smart mask ø115 2x Blstr
12810146 Smart mask ø115 2x Gold

Reflector

11949930 Reflector DIA 80 LED Spot
11949730 Reflector DIA 80 LED Flood

