

PRODUCT DATA SHEET

Part number 110509

EAN 4015609009138

Manufacturer WALTHER-WERKE

WEEE-Reg.-Number: DE 22131895

Product description

Wall socket for external fixing 16A 5P 9h with one top cable entry



Similar image

Detailed product description

WALTHER Wall socket 16A 5P 230V 9h IP44
 made from PA6 material
 with screw terminal
 for external fixing
 and with one top cable entry

Ordering Information

Order unit	Piece
Customs number	85366990
Net weight	0,2305 kg
Packing quantity (VPE)	10
Length of the packaging	
Width of the packaging	
Depth of the packaging	
Gross weight(VPE)	2,305 kg

Certificates

VDE certification 123017



Classification system

Classification system	ETIM_6.0
ETIM Class	EC001321

Technical product data

Model	Surface mounted (plaster)
IEC-amperage	16 A
Amperage acc. UL/CSA (for UL-version)	20 A
Number of poles	5
Voltage acc. EN 60309-2	230 V (50+60 Hz) blue
Clock hour position	9 h
Identification colour	Blue
RAL-number	5002
Degree of protection (IP)	IP44
Connection system	Screwed terminal
Material	Plastic
Type of fastening	External mounting
Insulated mounting	True

Dimension sheet

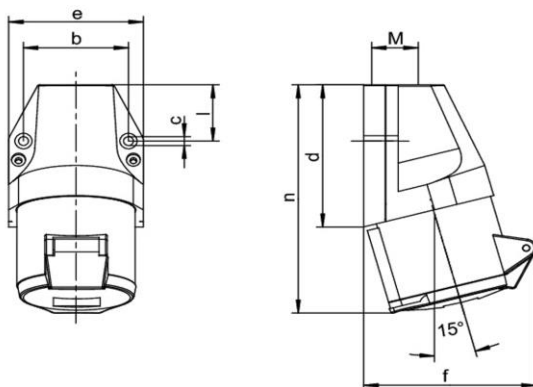

Amp.	16			32		
	3	4	5	3	4	5
b	45,5	60	60	60	60	60
c	5,3	5,3	5,3	5,3	5,3	5,3
d	74	80	80	97	97	97
e	60	74	74	82	82	82
f	75	86	90	103	103	105
l	28	31	31	45	45	45
n	120	128	129	154	154	155
M	20	20	20	25	25	25