

QUICK USER GUIDE

Wall-mounted charger

EV WALLBOX

BS 20

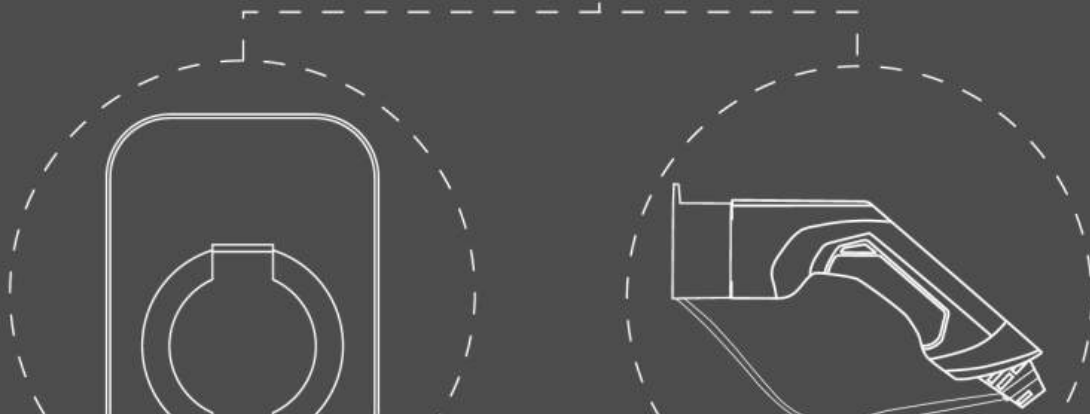
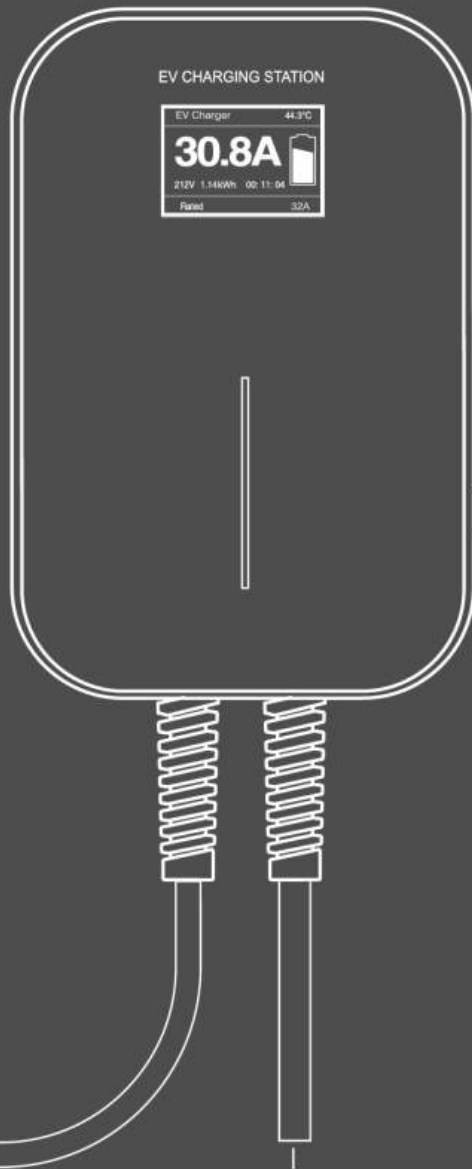

(MODE A)

(MODE C)

COMPONENTS IN THE BOX (MODE A)

PLATE

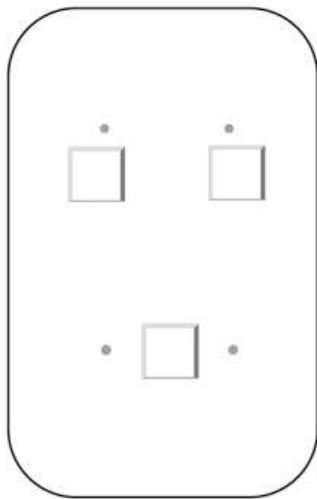

STATION

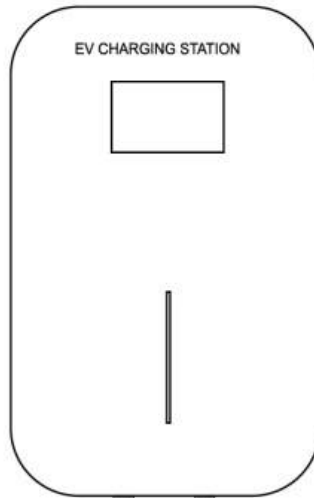

REFERENCE
PAPER

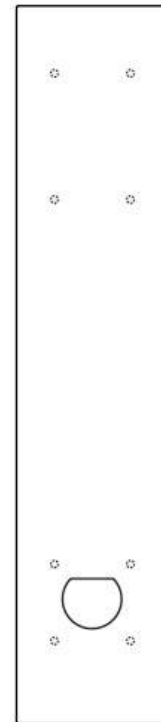

ALLEN KEY



30MM PLASTIC BOLTS
(FOR PLATE AND HOOK)

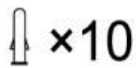

SHIM SCREWS

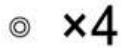

30MM SCREWS
(FOR PLATE AND HOOK)

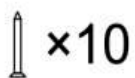

95MM SCREWS



30MM METAL BOLTS

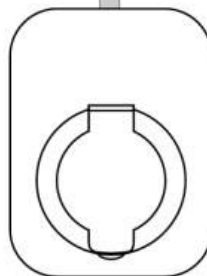
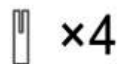

TOOLS NEEDED
FOR INSTALLATION

ELECTRIC DRILL

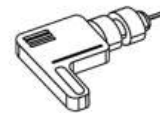

HAMMER



SCREWDRIVER



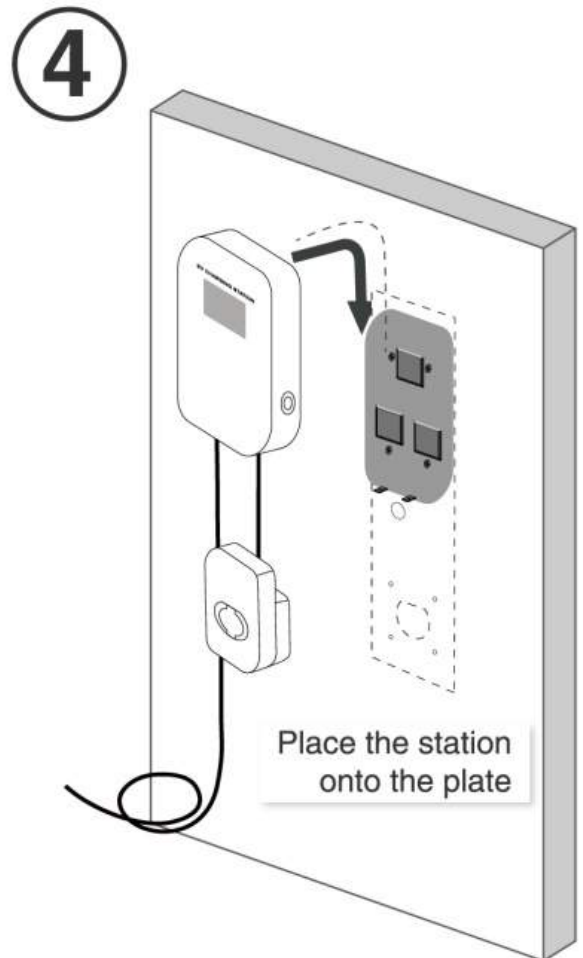
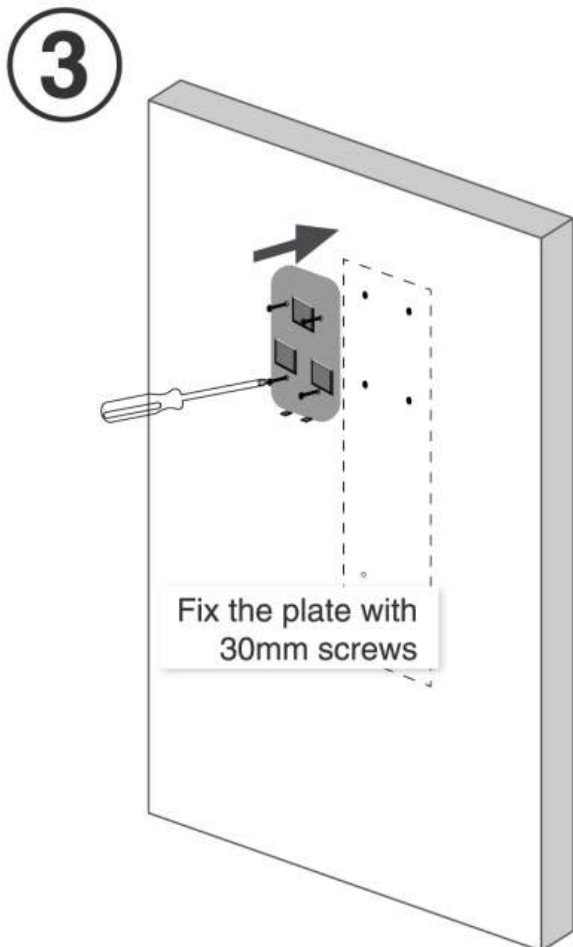
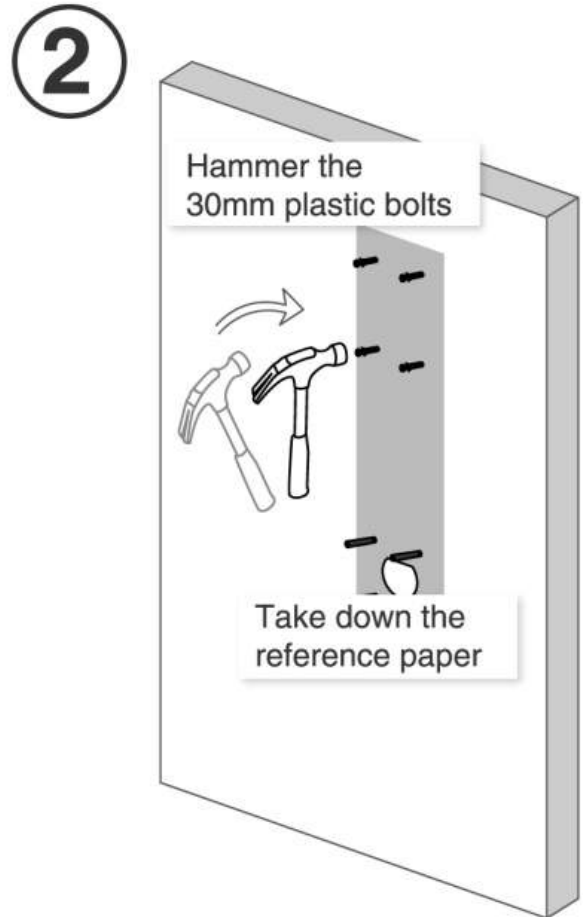
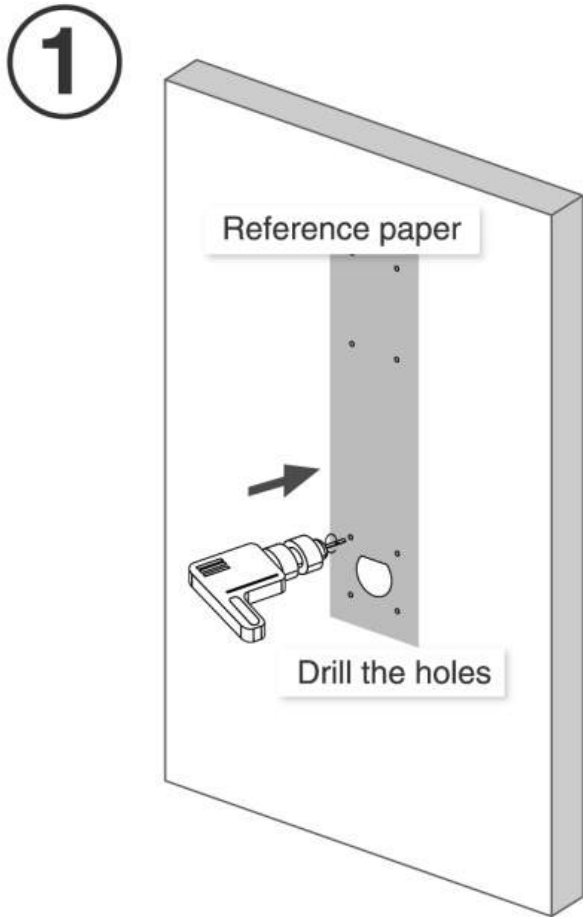

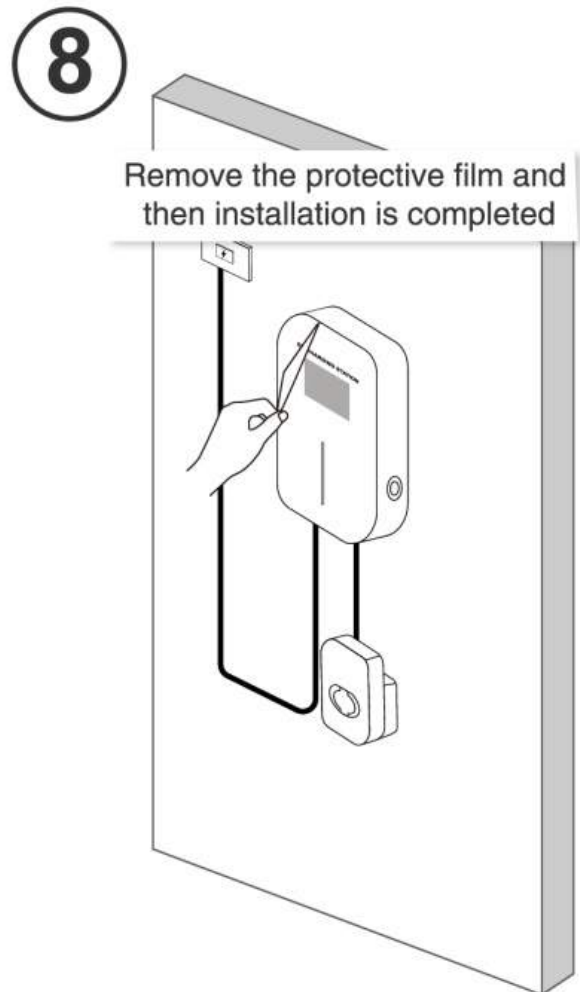
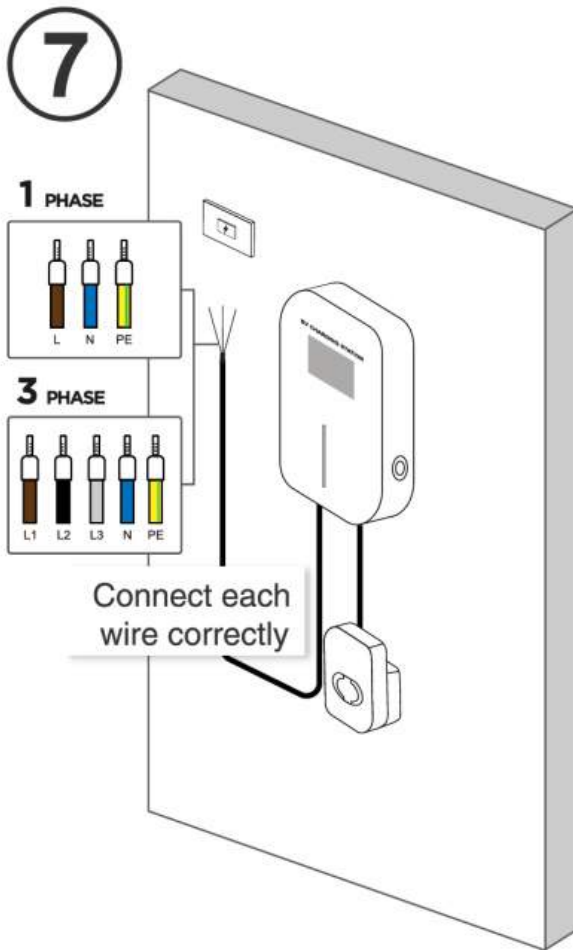
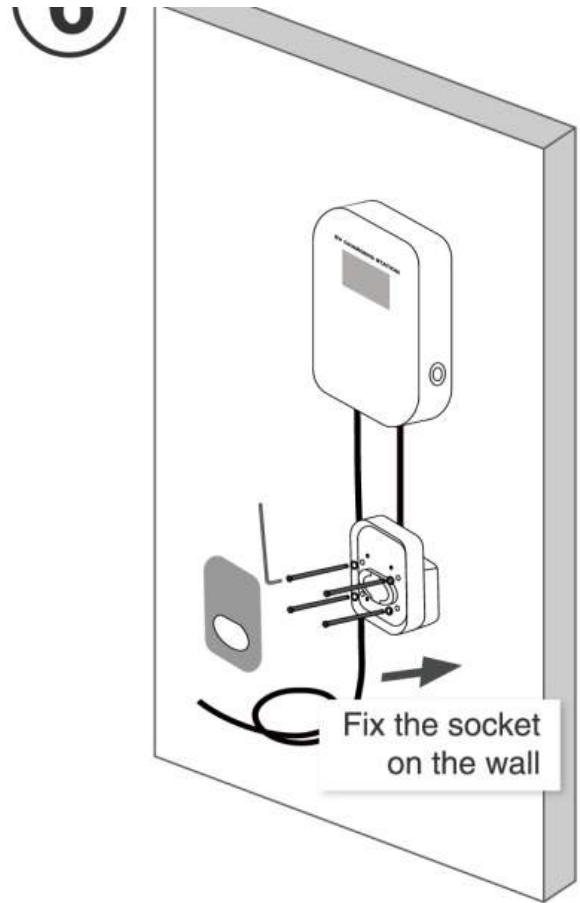
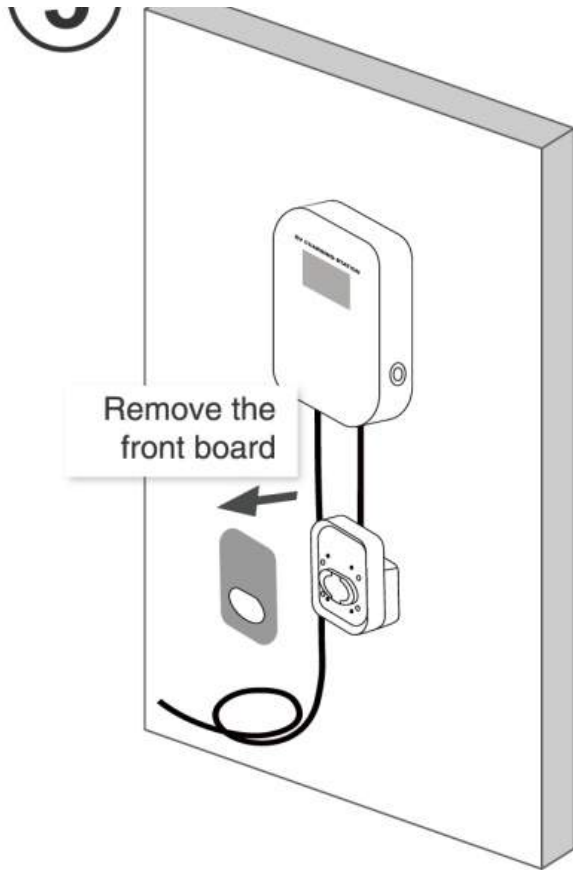

COMPONENTS IN THE BOX (MODE C)

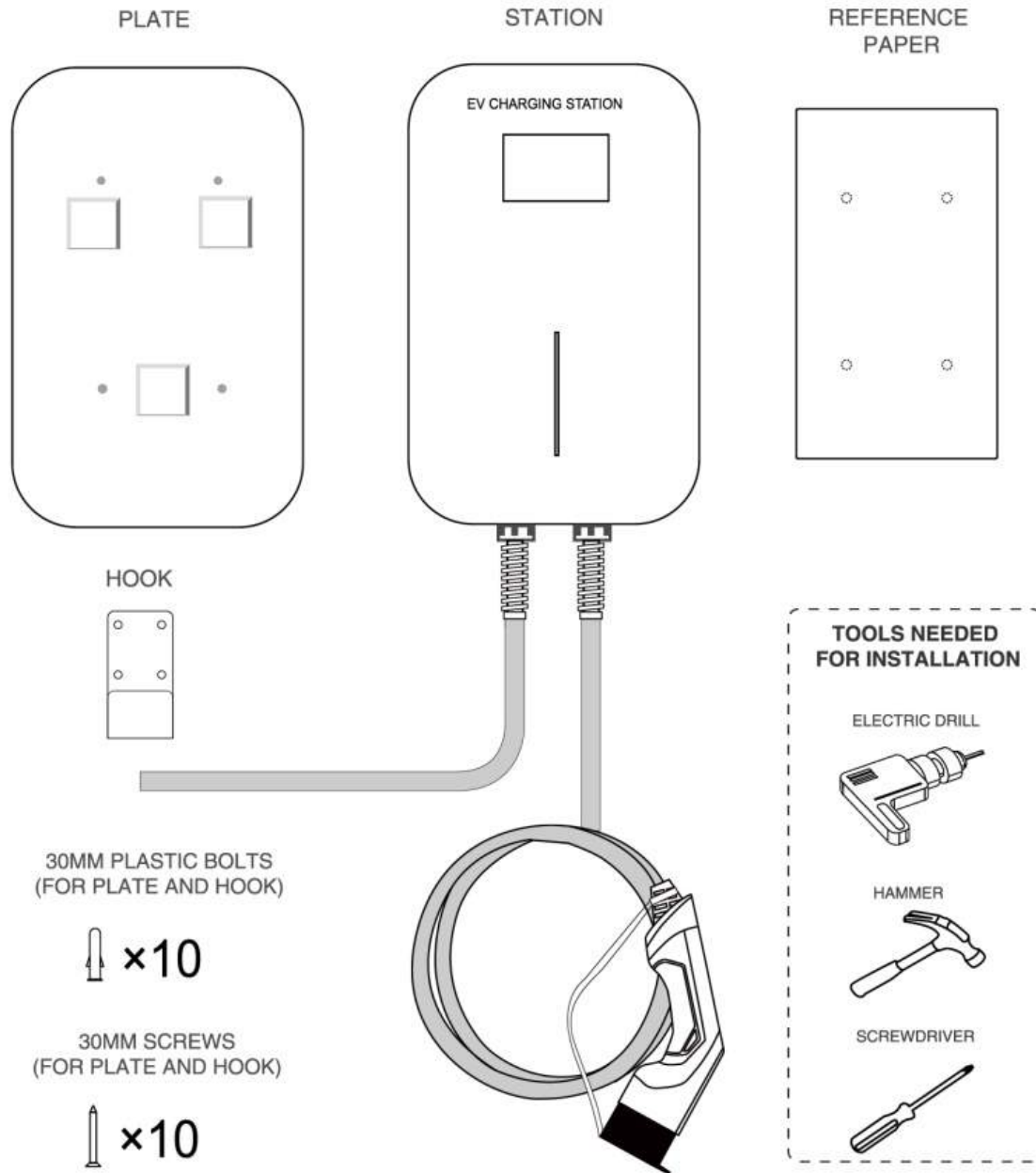

①

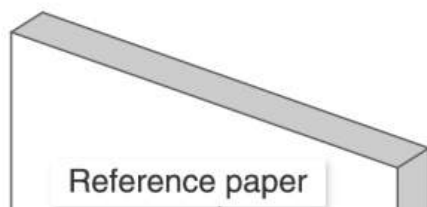

②

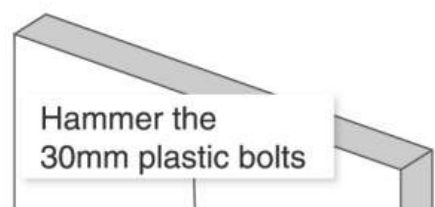

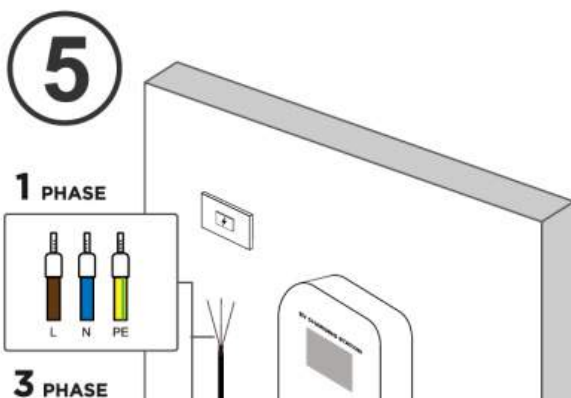
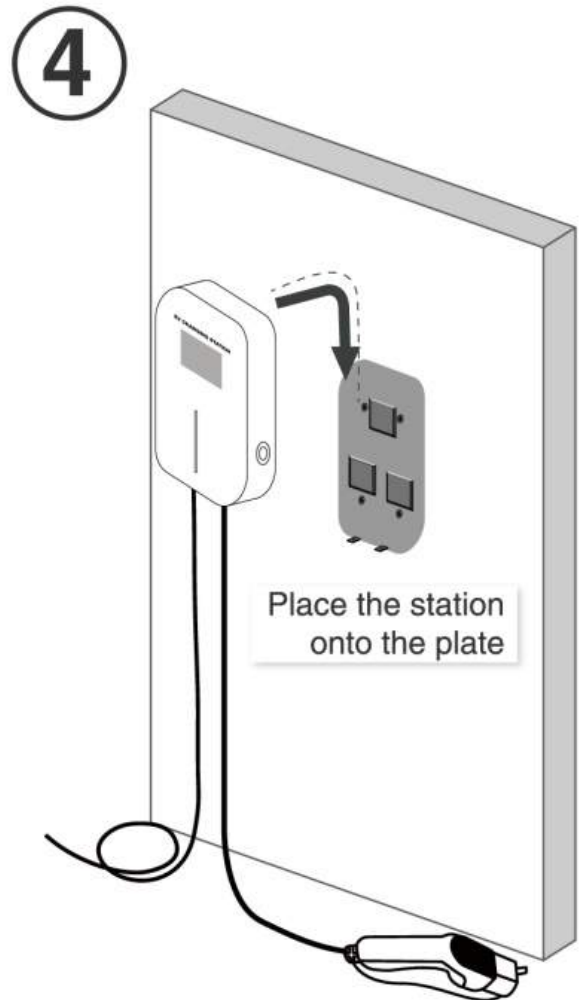
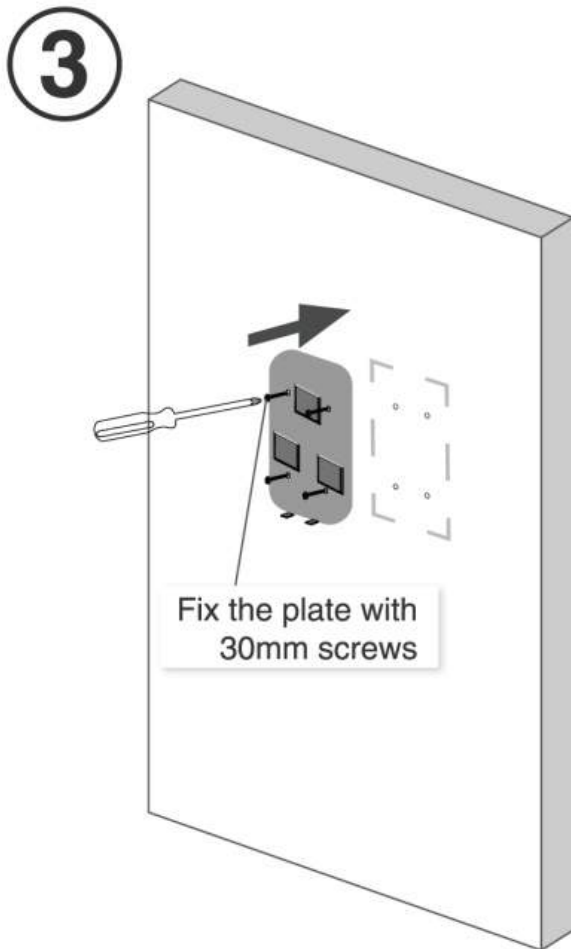
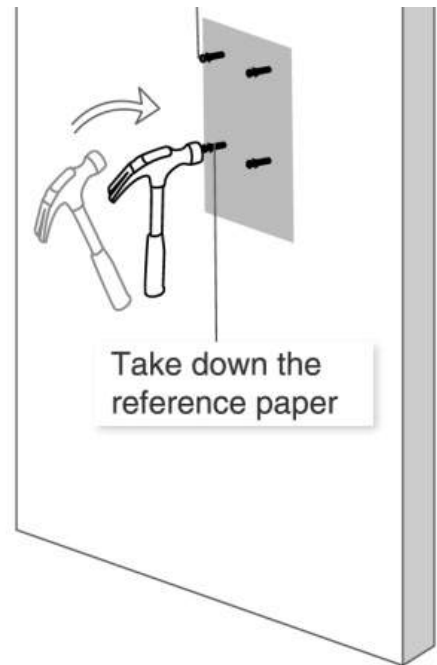
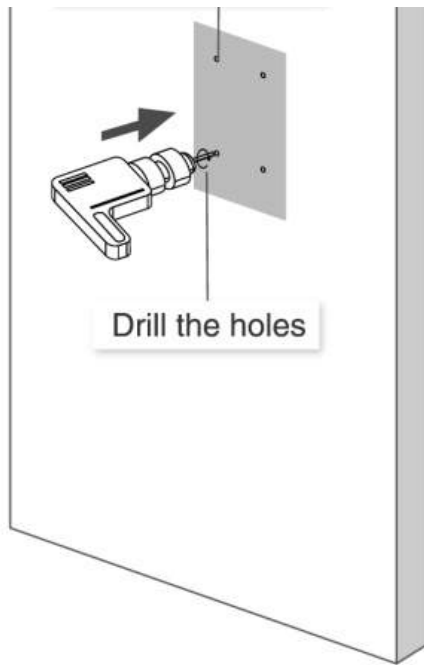

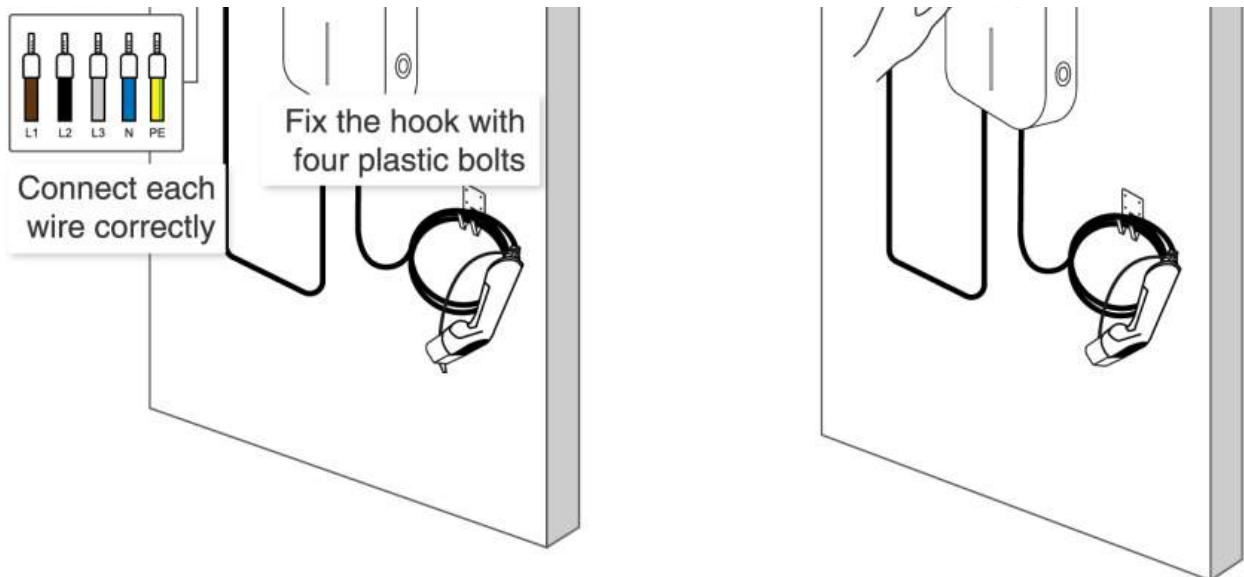

SECURITY WARNING

⚠ ATTENTION

Non-compliance with the operating instructions can cause serious consequences. Manufacturer does not assume any liability for damage caused by disregarding operating instructions or other warnings marked on the device.

High voltage could result in fire hazards ! Never use the device if the housing is damaged or opened!

This product is not suitable for people with limited mobility, sensory or psychological disabilities, and those who lack use experience or a certain degree of knowledge.

⚠ IMPORTANT SAFETY INSTRUCTIONS WARNING!

- ▲ This product should only be installed, repaired or maintained by authorized electricians and in accordance with national guidelines for electrical installations. All applicable local, regional and national regulations for electrical installations must be respected.
- ▲ Regularly check if the charger has visible damages. Do not use a damaged product.
- ▲ Make sure that all safety facilities and connections are available, properly installed and undamaged at all times and are tested regularly to ensure they can operate normally.
- ▲ Make sure that the input voltage, frequency, circuit breakers and other conditions of the device meet the specifications before the device is powered on. It's important to observe the maximum permissible charging current of the connection.
- ▲ Before powering on the device, please confirm that the device is properly grounded to avoid unnecessary accidents. If a ground fault occurs, it is assumed that the cable carries voltage. Please make sure there is no high-voltage power in the system before inspecting the device.
- ▲ Please insulate the unnecessarily exposed metal parts of all tools to prevent them from touching the metal frame, which may cause short circuit.
- ▲ To ensure the service life and stable operation of the charging station, the operating environment should be kept as clean as possible with a relatively stable temperature and humidity. The charging station must not be used in flammable environment or environments with volatile gas.
- ▲ Please keep the power cord away from the heated surface. Please do not put the power

▲ Please keep the power cord away from the heated surface. Please do not put the power cord in the gap of the closed door or pull it out of sharp edges or corners.

▲ Do not use the charger when the inside of the charging plug is wet.

▲ Do not modify, retrofit, or change any part by yourself under any circumstances.

▲ Please do not use this product as a toy. Please take good care of children to ensure that they will not play with this device as a toy nor put fingers into the charging connector when the power plug is still connected.

▲ The circuit to which the charger is to be connected must be equipped with a residual current circuit breaker.

 **Note**

Please do not use it for other purposes except electric car charging.
Do not try to disassemble the device by yourself under any circumstances. Otherwise, the internal precision parts may be damaged, and you will not be able to apply for after-sales service.

Version Number: BSN-ESP-B20CN-2104

Updated Date: April 28th, 2023