

SKV 16 SG

Cable gland, polyamide, Pg 16 RAL 7001

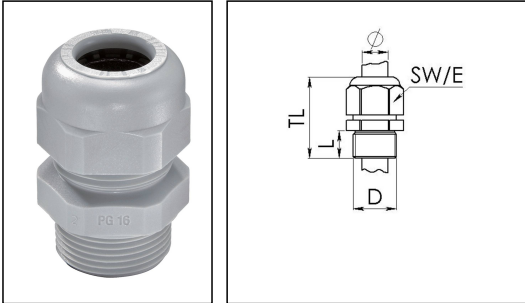

Products may differ in size, colour and appearance to those shown. If you require further information or customisation, please contact us directly.



Material cable gland	Polyamide
Material sealing gasket	EPDM
Protection class	IP68 (5 bar 30 min)
Temp. range min	-40 °C
Temp. range max	100 °C
Glow wire test	750 °C
Thread type	PG
Ø Connection thread D	16
Length screw-in thread L	11 mm
Ø cable diameter min	8 mm
Ø cable diameter max	14 mm
Key width SW	27 mm
Collar diameter (E)	29 mm
Total length TL	38 mm - 44 mm
Type of cable anchorage	A
Product Color	RAL 7001
Type	SKV 16 SG
Order no. RAL 7001	10066005
Packing unit	50
EAN number	4007685660051
Tariff number	39269097
ETIM-Classification	EC000441

Your Contact:

WISKA Hoppmann GmbH

Kisdorfer Weg 28 · 24568 Kaltenkirchen · Germany

☎ +49-4191-508-0 · 📠 +49-4191-508-209

contact@wiska.de · www.wiska.com

Recommended accessories

ADR 16	10061423
BS 14	10064011

14.02.2024

Your Contact:

WISKA Hoppmann GmbH

Kisdorfer Weg 28 · 24568 Kaltenkirchen · Germany

☎ +49-4191-508-0 · 📠 +49-4191-508-209

contact@wiska.de · www.wiska.com



Your Contact:

WISKA Hoppmann GmbH

Kisdorfer Weg 28 · 24568 Kaltenkirchen · Germany

☎ +49-4191-508-0 · 📠 +49-4191-508-209

contact@wiska.de · www.wiska.com