

Smart Kup 82 IP LED Warm Dim GE

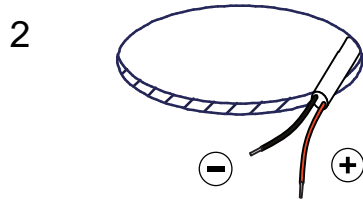

124740XX_124741XX_124742XX

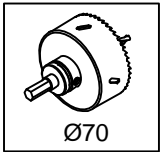
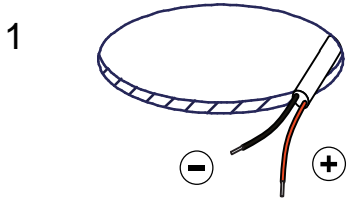

Drive Current (mA)	Forward Voltage		Power (W)
	min (Vf)	max (Vf)	
350	31	36	12

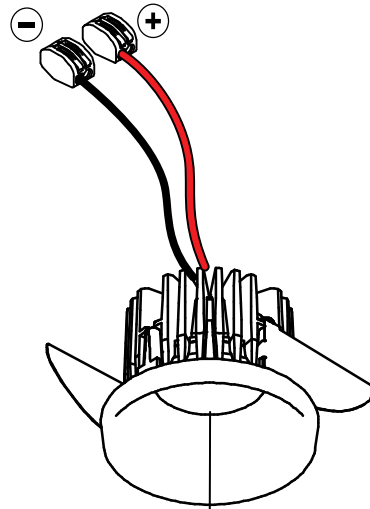
For serial connection, respect polarity!



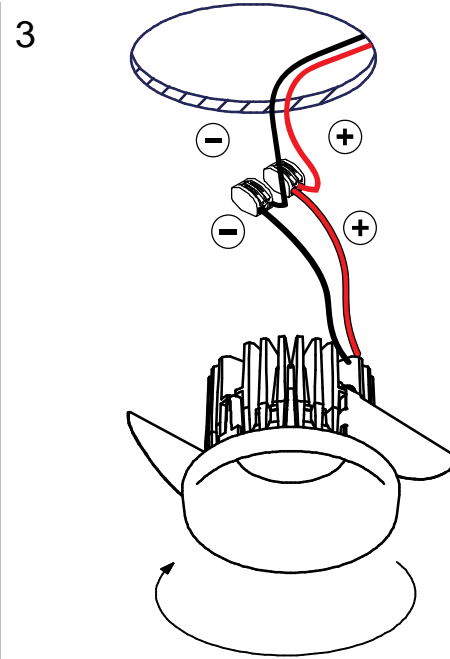

 Replace protective shield when broken.
 The luminaire shall only be used complete with its protective shield.
 Reference number: 1010754

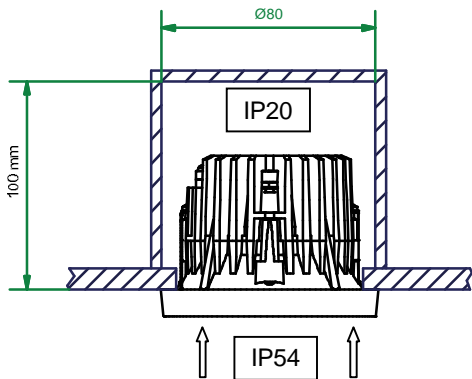
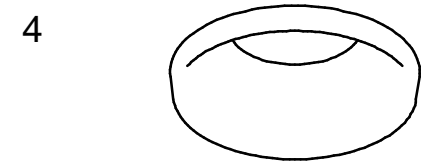

install : Twist clockwise
uninstall : Twist counterclockwise



 The light source contained in this luminaire shall only be replaced by the manufacturer or his service agent or a similar qualified person

CAN BE USED WITH

Drivers:
 V2 - 11/01/2017
 see driver matrix - latest version on website
 www.supermodular.com or check sales contact

Recessed ring:
 12500230 Recessed ring Ø70 H100

Surface box:
 125160XX Smart SBS 82 GE for LED
 125161XX Smart SBD 82 GE for 2xLED

Gypkit - conbox
 12290130 Gypkit 190X190X Ø70
 10889830 Conbox outer dim. 190x192x130

Mask:
 12500009 Smart Mask 82 1x WhStr
 12500032 Smart Mask 82 1x BlStr
 12500046 Smart Mask 82 1x Gold
 12500109 Smart Mask 82 2Lx WhStr
 12500132 Smart Mask 82 2Lx BlStr
 12500146 Smart Mask 82 2Lx Gold

