

DEEP VARO S1

DEEL  
PARTIE  
TEIL  
PART  
PARTE  
**A**

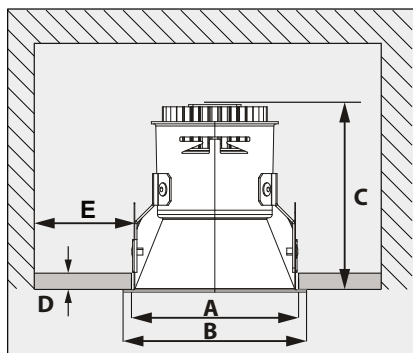
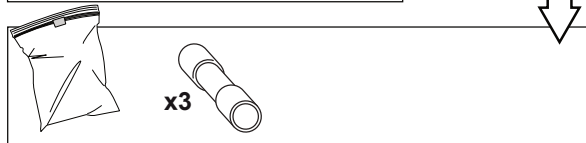

		mm
	A	Ø76
	B	Ø84
	C	≥90
	D	MIN. 5
	E	≥50

OPTIONS  
PLASTERKIT 101

202 11 19

I <sub>o</sub>	350mA
P <sub>o</sub>	7,1W
U <sub>f</sub> Typical	20,2V-DC

**IP20**

Beschermd tegen vaste voorwerpen die groter zijn dan 12 mm  
 Protégé contre les objets solides de plus de 12 mm  
 Geschützt gegen Festkörper größer als 12 mm  
 Protected against solid objects greater than 12 mm  
 Protegido contra objetos sólidos superiores a 12 mm  
 Protetto contro oggetti solidi più grandi di 12 mm

Enkel geschikt voor toestellen op zeer lage spanning (minder dan 50 V-AC / 120 V-DC)  
 Convient uniquement pour les produits à très basse tension (moins de 50 V-AC / 120 V-DC)  
 Geeignet für Güter mit sehr niedriger Spannung (unter 50 V-AC / 120 V-DC)  
 Only suited for goods at very low voltage (below 50 V-AC / 120 V-DC)  
 Se recomienda únicamente para aquellos productos de tensión muy baja (menos de 50 V-AC / 120 V-DC)  
 Vale unicamente per i prodotti a tensione molto bassa (inferiore a 50 V-AC / 120 V-DC)

Toestel niet geschikt om te worden afgedekt met thermische isolatie.  
 Luminaires non appropriées pour recouvrement d'un matériau isolant thermique.  
 Das Gerät/Die Leuchte darf nicht abgedeckt werden mit thermischer Isolation.  
 Luminare not suitable for covering with insulating material.  
 Luminaria no apta para cubrir con material aislante.  
 Apparecchio non adatto per essere coperto da materiale isolante.

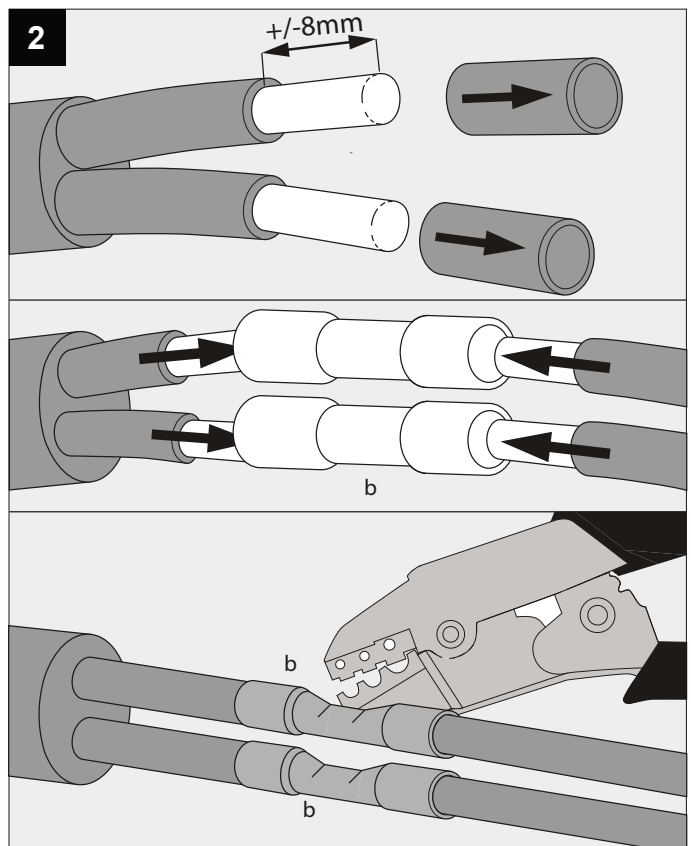
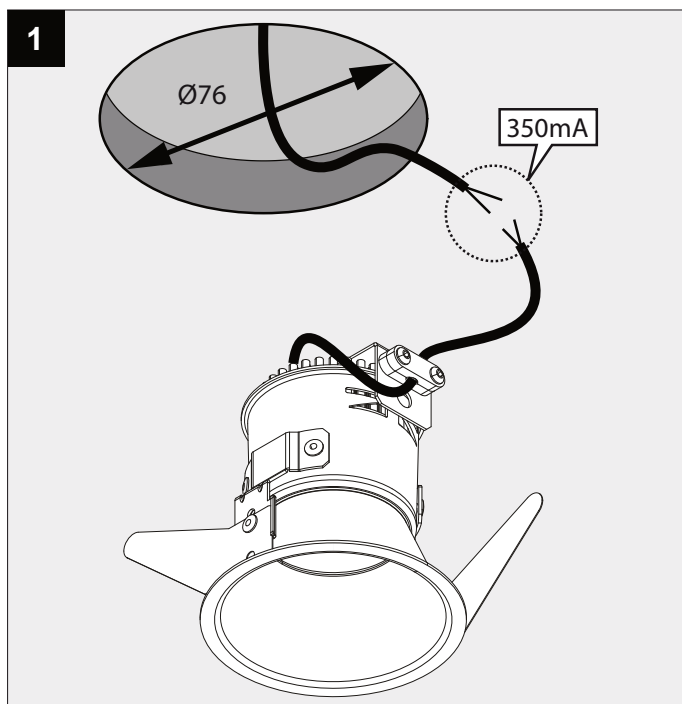

ELECTRICAL CONNECTION 

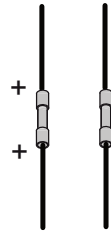

1 UNIT

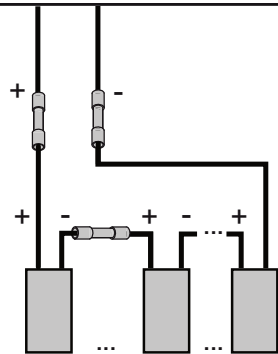

>1 UNIT



**ATTENTION**  
OBSERVE PRECAUTIONS FOR  
HANDLING ELECTROSTATIC  
DISCHARGE SENSITIVE  
DEVICES

NO SECONDARY SWITCHING

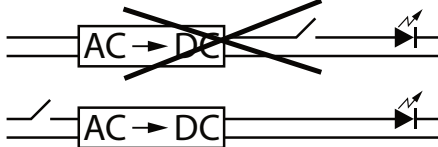

3

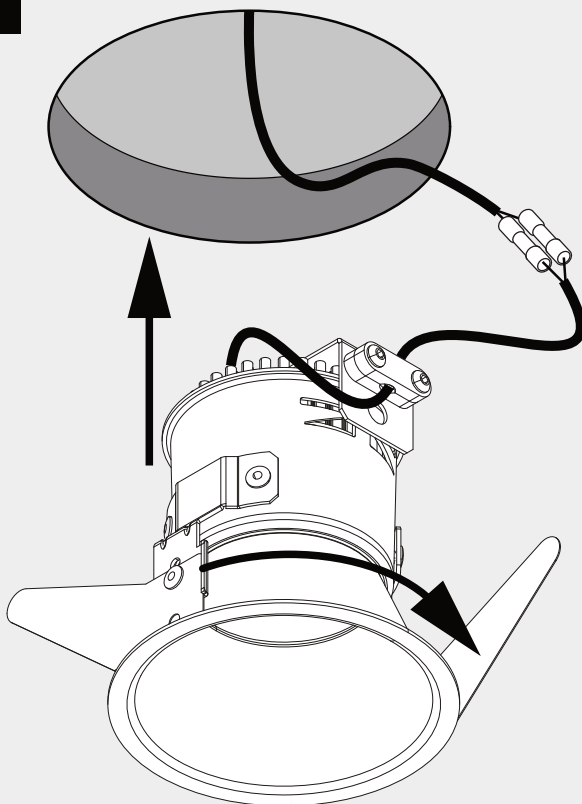

4

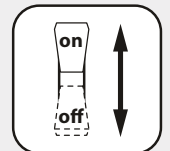
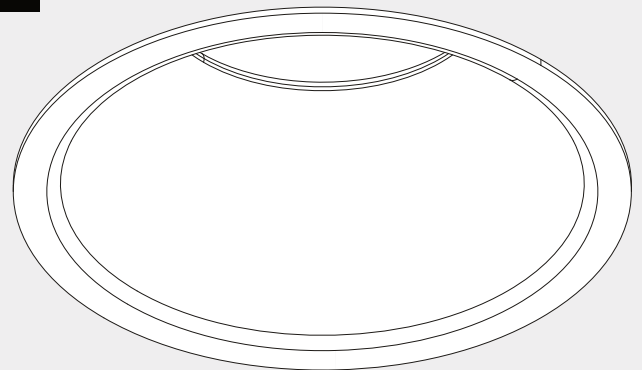

De verlichtingsbron van dit verlichtingstoestel zal enkel door de fabrikant of door de fabrikant aangestelde installateur vervangen worden.

La source lumière de cet appareil ne sera remplacée que par l'entreprise ou par un agent reconnu.

Das enthaltene Leuchtmittel sollte nur durch entsprechendes Fachpersonal ersetzt werden.

The light source contained in this luminaire shall only be replaced by the manufacturer or his service agent.

La fuente de iluminación que tiene esta luminaria sólo puede remplazarse por el fabricante o por un instalador autorizado.

La sorgente luminosa incorporata in questo apparecchio può essere sostituita solo dal produttore, da un suo centro assistenza oppure da una persona in possesso della necessaria abilitazione.

Replaceable (LED only) light source by a professional  
可由专业人士更换 (仅限于LED) 光源  
Сменный (только светодиодный) источник света только квалифицированным персоналом  
مصدر الضوء (إيد فقط) قابل للتغيير بمعرفة المتخصص.

 Verlichtingsbron (enkel LED) kan enkel vervangen worden door een professional  
La source d'éclairage (uniquement LED) ne peut être remplacée que par un professionnel  
Die Lichtquelle (nur LED) kann nur von einem Fachmann ausgetauscht werden  
La fuente de iluminación (solo LED) y equipo de control solo puede ser reemplazada por un profesional  
La fonte di illuminazione (solo LED) può essere sostituita solo da un professionista

 This product contains a light source of energy efficiency class E  
本产品包含能效等级为 E 的光源  
Этот артикул содержит источник света с энергоэффективностью класса E  
يحتوي هذا المنتج على مصدر ضوء ذو كفاءة الطاقة E

Dit product bevat een verlichtingsbron van energie-efficiëntieklasse E  
Ce produit contient une source d'éclairage de classe d'efficacité énergétique E  
Dieses Produkt enthält eine Lichtquelle der Energieeffizienzklasse E  
Este producto contiene una fuente de iluminación de clase de eficiencia energética E  
Questo prodotto contiene una fonte di illuminazione in classe di efficienza energetica E