

## PRODUCT DATA SHEET

---

Part number 111409

---

EAN 4015609009367

Manufacturer WALTHER-WERKE

WEEE-Reg.-Number: DE 22131895

### Product description

---

Wall socket for internal fixing 16A 4P 9h with two knock-out cable entries both on top and bottom and one knock-out floor entry



Similar image

### Detailed product description

---

WALTHER Wall socket 16A 4P 230V 9h IP44  
 made from PA6 material  
 with screw terminal  
 for internal fixing  
 with two knock-out cable entries both top and bottom  
 and one knock-out floor entry





### Ordering Information

---

Order unit	Piece
Customs number	85366990
Net weight	0,3804 kg
Packing quantity (VPE)	5
Length of the packaging	
Width of the packaging	
Depth of the packaging	
Gross weight(VPE)	1,902 kg

### Certificates

---

VDE certification	123017	
UL certification	No. E83342	
UL certification	No. E188992	
EAC certification	BY112.02.01.020 06089	

## Classification system

---

Classification system	ETIM_6.0
ETIM Class	EC001321

## Technical product data

---

Model	Surface mounted (plaster)
IEC-amperage	16 A
Amperage acc. UL/CSA (for UL-version)	20 A
Number of poles	4
Voltage acc. EN 60309-2	230 V (50+60 Hz) blue
Clock hour position	9 h
Identification colour	Blue
RAL-number	5002
Degree of protection (IP)	IP44
Connection system	Screwed terminal
Material	Plastic
Type of fastening	Inner lying mounting
Insulated mounting	True

## Dimension sheet

---

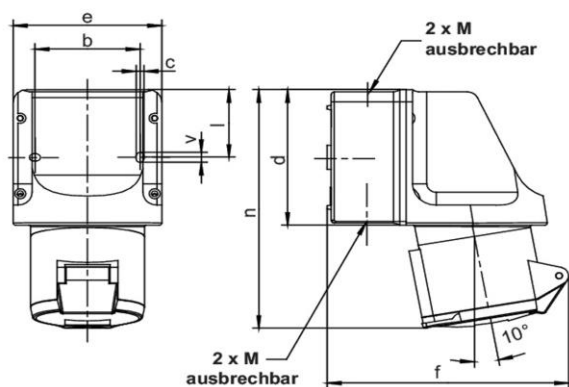

Amp.	16			32		
	3	4	5	3	4	5
b	66,5	66,5	66,5	66,5	66,5	66,5
c	5	5	5	5	5	5
d	96	96	96	96	96	96
e	95	95	95	95	95	95
f	140	143	146	154	154	157
l	47,5	47,5	47,5	47,5	47,5	47,5
n	160	164	164	173	173	173
v	7	7	7	7	7	7
M	20/25	20/25	20/25	20/25	20/25	20/25