

PRODUCT DATA SHEET

Part number	179409
EAN	4015609011711
Manufacturer	WALTHER-WERKE
WEEE-Reg.-Number:	DE 22131895

Product description

Waterproof wall socket for internal fixing 125A 4P 9h with two cable entries both top and bottom and terminal set



Product image



Detailed product description

WALTHER Wall socket 125A 4P 230V 9h IP67
 made from PA6 material
 multi-contact = higher contact pressure – light pull-off force
 for internal fixing
 two top cable entries: M50/M20
 and two bottom cable entries: M40
 with terminal set 4x50 qmm

Ordering Information

Order unit	Piece
Customs number	85366990
Net weight	3,26 kg
Packing quantity (VPE)	1
Length of the packaging	
Width of the packaging	
Depth of the packaging	
Gross weight(VPE)	3,26 kg

Certificates

VDE certification	123029	
EAC certification	BY112.02.01.020 06089	

Classification system

Classification system	ETIM_6.0
ETIM Class	EC001321

Technical product data

Model	Surface mounted (plaster)
IEC-amperage	125 A
Amperage acc. UL/CSA (for UL-version)	100 A
Number of poles	4
Voltage acc. EN 60309-2	230 V (50+60 Hz) blue
Clock hour position	9 h
Identification colour	Blue
RAL-number	5002
Degree of protection (IP)	IP67
Connection system	Screwed terminal
Material	Plastic
Type of fastening	Inner lying mounting
Insulated mounting	True

Dimension sheet

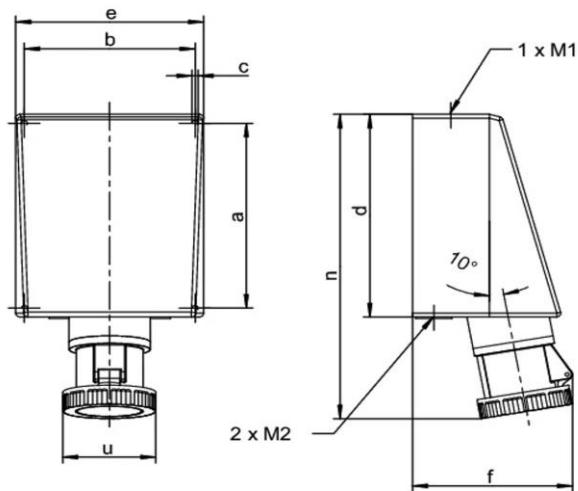

Amp.	125		
Pole	3	4	5
a	240	240	240
b	200	200	200
c	7	7	7
d	263	263	263
e	220	220	220
f	190	190	190
n	406	406	406
u	130	130	130
M 1	20/50	20/50	20/50
M 2	40	40	40