

Smart Lotis 82 IP LED<900L 2,7KM GE

124421XX

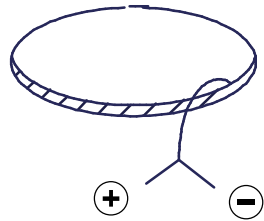

350mA - min 16,5Vf - max 19,2Vf - 6,2W
 500mA - min 17,1Vf - max 19,8Vf - 9,2W

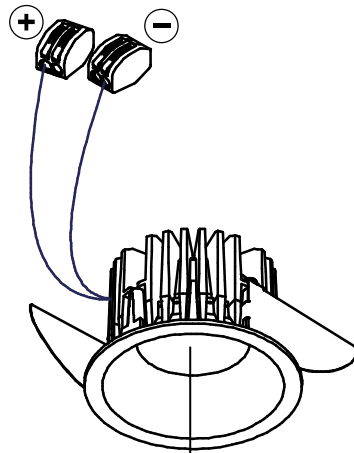
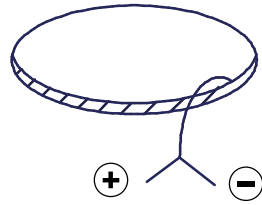
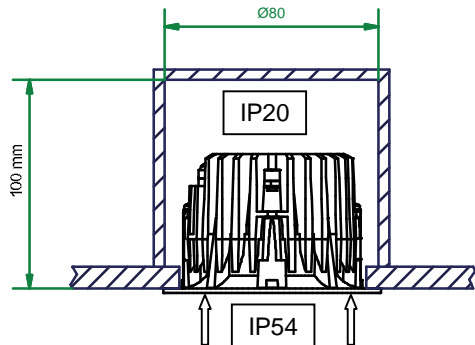
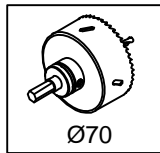

Replace protective shield when broken.
 The luminaire shall only be used complete with its protective shield.
 Reference number: 1010754

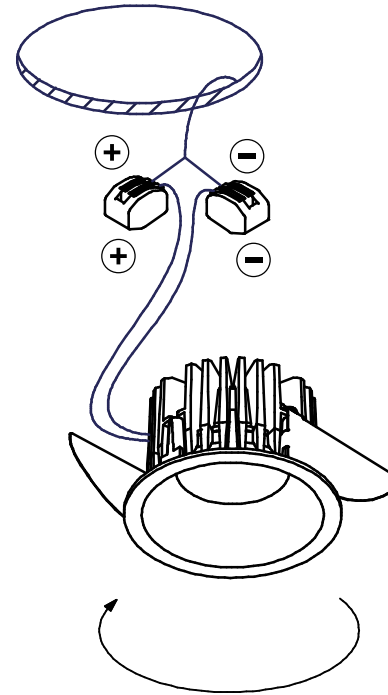

install : Twist clockwise
 uninstall : Twist counterclockwise

The light source contained in this luminaire shall only be replaced by the manufacturer or his service agent or a similar qualified person

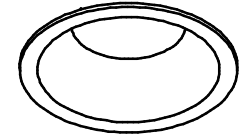

CHECK DIP-SWITCHES ON DRIVER

ON
 OFF 1 2 3 4 5 6

check dipswitch settings on driver
 Push Dim max 5 drivers on 1 push button

Drivers:
 see driver matrix - latest version on website
www.supermodular.com or check sales contact

